

50 Hydraulic Excavator

Table of Contents

DIVISION/SECTION	SECTION No.	REFERENCE No.
1 GENERAL INFORMATION		
Safety instructions, General Information and Torque Specifications	1001	7-84400GB
General Specifications	1002	7-84410GB
2 ENGINE		
Engine Removal and Installation	2000	7-84420GB
Radiator and Oil Cooler	2003	7-21000GB
Engine Basic Data, Engine Specifications, Special Torque Specifications and Troubleshooting	2401	7-21020GB
Cylinder Head and Valve Assembly	2415	7-21030GB
Cylinder Block, Crankshaft, Pistons, Connecting Rods, Liners, Timing Gear Housing and Flywheel	2425	7-21040GB
Engine Lubrication System, Oil Pump and Relief Valve	2445	7-21050GB
Engine Cooling System, Thermostat, Water Pump, Fan	2455	7-21060GB
Filtration/Exhaust	2465	7-21070GB
3 FUEL SYSTEM		
Fuel System, Injection Pump, Injectors, Fuel Filter, Fuel Pump	3412	7-21080GB
4 ELECTRICAL SYSTEM		
Electrical Schematic	4001	7-84430GB
Starter Motor	4004	7-84440GB
Alternator	4007	7-84450GB
5 UNDERCARRIAGE		
Track Group	5002	7-84460GB
6 DRIVE TRAIN		
Travel Motor/Reduction Gear Assembly	6002	7-84470GB
Swing Reduction Gear	6003	7-84480GB
7 UNDERCARRIAGE HYDRAULICS		
Hydraulic Swivel	7004	7-84490GB
8 HYDRAULIC SYSTEM		
Hydraulic Schematic, Inspections, Adjustments and Troubleshooting	8001	7-84500GB
Swing Control Valve Dozer Blade	8005	7-84600GB
Attachment, Travel, Offset and Option Control Valve	8007	7-84510GB
Hydraulic and Fuel Reservoir	8010	7-84990GB
Hydraulic High Pressure and Swing Pump	8020	7-84520GB
Hydraulic Servo-Pump	8021	7-84530GB
Swing Motor	8040	7-84540GB
Attachment / Swing Pilot Valves	8050	7-84950GB
Attachment Cylinders	8080	7-84550GB
9 UPPERSTRUCTURE/ATTACHMENTS		
Pedals and Levers	9001	7-84560GB
Upperstructure and Turntable	9002	7-84570GB
Cab	9007	7-84580GB
Bucket, Boom, Dipper, Pivot and Dozer Blade	9008	7-84590GB

<https://caseihservicemanual.com>

Section

1001

**SAFETY INSTRUCTIONS,
GENERAL INFORMATION AND
TORQUE SPECIFICATIONS**

<https://caseihserviceannual.com>

TABLE OF CONTENTS

SAFETY.....	3
Parking the machine	3
Maintenance and adjustments	3
Prevention of fire or explosions.....	5
Prevention of burns.....	5
GENERAL INFORMATION	6
TORQUE SPECIFICATIONS FOR HYDRAULIC UNIONS.....	7
NUT AND SCREW TORQUE SPECIFICATIONS (CLASS 10.9).....	9
PLUG AND PLASTIC PLUG REFERENCE	10
TABLE OF LOCTITE PRODUCTS.....	11

<https://caseihservicemanual.com>

SAFETY

Follow the safety instructions given in this section and throughout this manual to prevent any risk of accident.

Parking the machine

- When parking the machine, proceed as follows:
 1. Park the machine on flat, level ground, away from any soft ground, excavations or badly shored cavities.
 2. Place the upperstructure and the attachment in line with the undercarriage, retract the attachment and anchor the bucket or the clamshell in the ground.
 3. Lower the dozer blade to the ground.
 4. Shut down the engine and remove the starter switch key.
 5. It is essential to lift the left-hand control arm before leaving the operator's compartment.
 6. Lock the operator's compartment door.
 7. Make sure that the hoods are correctly locked.
 8. Make sure that no component of the machine is protruding onto the public highway. If this cannot be avoided, install signals in conformity with regulations.

Maintenance and adjustments

- Do not carry out any maintenance operations until you have read and assimilated the instructions and warnings contained in this manual.
- Wear suitable clothing when servicing the machine. Avoid loose-fitting clothes.
- When servicing the machine, place a "Do not start up" label on the instrument panel.
- Always wear eye protection when using a tool which can cause metal particles to be projected. Use a soft-faced hammer (copper or brass) when installing pins.
- Incorrectly performed maintenance or adjustments can cause serious injuries. If you do not understand a maintenance or adjustment procedure, consult your Dealer.
- If the attachment is raised or if the machine moves when there is no operator, serious injury can result. Before carrying out any servicing operations on this machine, proceed as follows:
 1. Park the machine on flat, level ground.
 2. Lower the attachment until it is resting on the ground.
 3. Shut down the engine and remove the starter switch key.
 4. Block the tracks to prevent any machine movement.
- To operate the machine or the attachment controls, it is essential for the operator to be seated in his seat. Any other manner of operation could cause a serious accident.
- This is a machine for one person only. No passenger is permitted.

- Unauthorized modifications made to this machine may cause serious injury. Do not undertake any modification to the machine without prior authorization from your Dealer. Any modifications made must be in conformity with the technical specifications of the machine and any current safety legislation requirements.
- Certain components of the machine are subject to type approval. When replacing such components, it is compulsory to make sure that they conform to regulations. For safety's sake, use genuine parts.
- Pressurized hydraulic fluid or grease which penetrates the skin can cause serious injury. Take the necessary safety precautions (safety clothing and protection for the face and hands) to avoid such risks. Also, before using these products, read the manufacturer's instructions concerning their use. If hydraulic fluid penetrates the skin, call a doctor immediately.
- Pressure in the track tension cylinders is high. Carefully follow the procedure described in this manual to increase or decrease track tension.
- Whenever carrying out a welding operation on the undercarriage or upperstructure chassis, as authorized by the manufacturer and in accordance with his instructions, disconnect the battery, the B+ and D+ cables of the alternator and connect the welding apparatus earth cable to the component on which the welding operation is to be performed. Never connect the welding apparatus earth cable to the undercarriage when welding on the upperstructure (or vice-versa). Never connect the welding apparatus earth to a component of the hydraulic system.
- When using compressed air, take the necessary safety precautions to protect your face.
- Before starting the engine, study the safety messages contained in this manual. Read all the signs concerning safety which are on the machine. Make sure that no person is within the machine's working area. Learn how to use the controls in a safe manner before using them. You must understand and follow the manufacturer's instructions concerning the operation and maintenance of the machine and you must observe current laws and regulations. You can order the relevant operator's manual and service manual from your Dealer.
- If you wear clothing which is too loose-fitting or if you do not use safety equipment suitable for your work, you risk having an accident. Always wear clothing which does not catch on objects. Among supplementary safety equipment which may be necessary are a helmet, safety shoes, ear, eye and face protection, thick gloves, and reflective clothing.
- When carrying out any operation near the fan when the engine is running, avoid wearing loose-fitting clothing and take great care.
- When carrying out inspections and tests on the hydraulic equipment, follow the procedures to the letter. DO NOT CHANGE the procedures.
- Make sure that no person is within the working range of the hydraulic cylinders when they are being operated to test their operation or to bleed air from the system.
- Use heat-proof gloves when handling hot parts.
- When using a hammer to install pivot pins or accessories which are operated by compressed air, or yet again when using a grinder, it is necessary to wear protection which covers the eyes completely (work goggles or any other authorized protection).
- To raise the wheels or tracks off the ground, use jacks, chain lift hoists and carry out such work on suitable ground. Always place suitable, safe blocks under the machine.
- When maintaining or servicing a machine, there must be no oil, grease, tools, etc. on the workshop floor, the cab floor or on the steps. If necessary, use a product to absorb the oil and wear workshop overalls. Always employ safe methods of working.
- Exhaust gases can cause death. If it is necessary to run an engine in an enclosed space, the exhaust fumes must be evacuated from the area by means of an evacuation pipe. Open the doors and allow air from the outside to enter the building where the engine is running.
- Certain components of this machine are very heavy. Use suitable lifting equipment or request assistance as indicated in this manual.

Prevention of fire or explosions

- Engine fuel can cause an explosion or a fire.
 - Never refuel when the engine is running.
 - Never smoke when refuelling.
 - Take all necessary safety measures when welding, grinding or when working near a naked light.
- Always use a non-inflammable solvent when cleaning parts.
- A spark or a naked light can cause the hydrogen in a battery to explode. To avoid all risk of explosion, be sure to follow the instructions below:
 - When disconnecting battery cables, always disconnect the negative cable (-) first.
 - When connecting battery cables, always connect the negative cable (-) last.
 - Never short-circuit the battery terminals with metal objects.

Prevention of burns

- The electrolyte in the batteries can cause serious burns. Batteries contain sulphuric acid. Avoid contact with skin, eyes and clothing.
Antidote:
EXTERNAL: rinse with water.
INTERNAL: drink large amounts of water or milk. Then drink milk of magnesia, a beaten egg or vegetable oil. Call a doctor immediately.
EYES: rinse with water for fifteen minutes and consult a doctor immediately.

- Do not weld, grind or smoke near a battery.
- Sparks can fly from the electrical system or the engine exhaust. Before running the machine in an area where there may be inflammable gases, make sure that there is adequate ventilation.
- Make sure that there is always a fire extinguisher within easy reach on board the machine. Make sure the fire extinguisher is regularly serviced in accordance with the manufacturer's instructions.
- Clean the machine regularly, removing all debris and inflammable material.
- Make sure there are no leaks and replace any damaged hoses, lines or connectors. After any repair work, clean the machine before operating it.
- When battery electrolyte freezes it can explode if you try to charge the battery or to start the engine with a booster battery. Keep batteries charged at all times to prevent the electrolyte from freezing.
- Boiling coolant solution can escape if the coolant reservoir cap is removed when the system is still hot. Before removing the cap, let the system cool down and then turn the cap to the first notch, waiting until all pressure is released. Then remove the cap.

GENERAL INFORMATION

CLEANING

Clean all metal parts, except ball or roller bearings with white spirit or steam. Do not use caustic soda when steam-cleaning. After cleaning, dry and oil all parts. Clean oil passages with compressed air. Clean ball or roller bearings with paraffin, dry them completely and lubricate them.

INSPECTION

Inspect all parts when they have been disassembled. Replace any parts which show wear or damage. Shallow scuffing or scratches can be removed by honing or with a rag soaked in jeweller's rouge. A complete inspection to detect wear and pitting and the replacement of the parts concerned as required avoid premature failures.

BALL AND ROLLER BEARINGS

Check that bearings run freely. If their clearance has become too great or if they run irregularly, they must be replaced. Wash bearings using a good solvent or paraffin and allow them to dry in the air. NEVER DRY BEARINGS WITH COMPRESSED AIR.

NEEDLE ROLLER BEARINGS

Before pressing needle roller bearings into a bore, always remove any metal protrusions from the bore or its edges. When needle roller bearings are to be inserted by means of a press, first coat the inside and the circumference of the bearings with Vaseline before insertion.

GEARS

Check all gears to ensure they show no signs of wear or damage. Replace worn or damaged gears.

SEALING RINGS, O-RINGS AND GASKETS

Always install new sealing rings, O-rings and gaskets. Coat sealing rings and O-rings with Vaseline before installation.

SHAFTS

Check all shafts showing signs of wear or damage. Check that the surface of any shaft carrying a bearing or a sealing ring is not damaged.

REPLACEMENT PARTS

Always install genuine replacement parts. When passing orders for replacement parts, consult the Parts Catalogue so as to provide the correct part number for the genuine replacement parts. Failures caused by the use of parts other than genuine parts are not covered by the warranty.

LUBRICATION

Use only the oils and lubricants specified in the operator's manual or the service manual. Failures caused by the use of non-specified oils or lubricants are not covered by the warranty.

<https://caseinsertvicemannual.com>

TORQUE SPECIFICATIONS FOR HYDRAULIC UNIONS

Hose

Thread	Torque specifications (Nm)	
	A	B
1/8"	10 to 15	10.8 to 13.2
1/4"	25 to 30	27 to 33
3/8"	50 to 55	49.5 to 60.5
1/2"	60 to 65	81 to 99
3/4"	120 to 125	135 to 165
1"	140 to 145	180 to 220

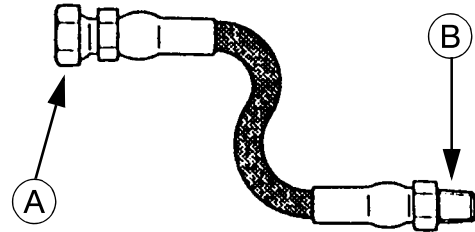

CS98C022

Pipe nut

External diameter of tube	Torque specifications (Nm)
8	30 to 40
10	37.5 to 47.5
12	55 to 65
15	85 to 95
16	90 to 100
18	130 to 140
22	200 to 220
27.2	240 to 260
28	300 to 340
32	300 to 340
35	400 to 440

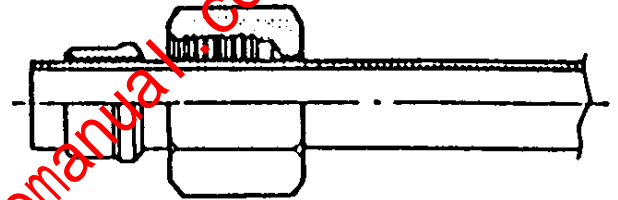

CS98B137

<https://caseinservicemanual.com>

Steel tube union

Nominal gas thread dia.	Torque specifications (Nm)	
	Steel	Cast steel
1/8"	10.8 to 13.2	9.9 to 12.1
1/4"	27 to 33	22.5 to 27.5
3/8"	49.5 to 60.5	45 to 55
1/2"	81 to 99	67.5 to 82.5
3/4"	135 to 165	117 to 143
1"	180 to 220	157.5 to 192.5

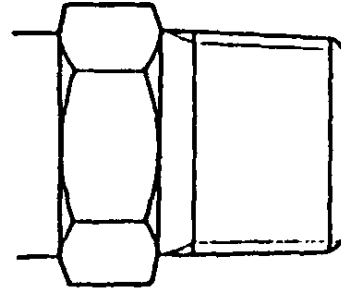

CS98B138

Pipe union with O-ring

Nominal gas thread dia.	Torque specifications (Nm)
1/8"	18 to 22
1/4"	30 to 40
3/8"	50 to 60
1/2"	60 to 70
3/4"	90 to 100
1"	100 to 120
1"-1/4"	110 to 130
1"-1/2"	130 to 150

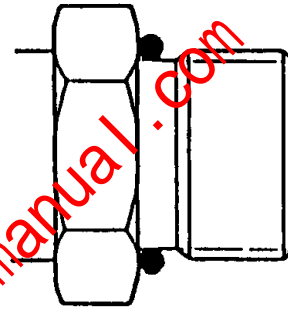

CS98B139

Nominal gas thread dia.	Torque specifications (Nm)
7/16-20	15 to 19
1/2-20	21 to 25
9/16-18	29 to 35
3/4-16	56 to 66
1-5/16-12	88 to 110
1-5/16-12	130 to 146
1-5/8-12	175 to 195

NUT AND SCREW TORQUE SPECIFICATIONS (CLASS 10.9)

Category	Diameter x pitch	Torque specifications (Nm)	
		Standard	Special
Coarse pitch	M6X1.0	9 to 11	11 to 13
	M8X1.25	22 to 24	26 to 28
	M10X1.5	46 to 50	53 to 59
	M12X1.5	85 to 93	99 to 109
	M12X1.75	81 to 89	94 to 104
	M14X2.0	130 to 144	151 to 167
	M16X2.0	201 to 223	234 to 258
	M20X2.5	398 to 440	461 to 509
Fine pitch	M6X		
	M8X1.0	24 to 26	28 to 30
	M10X1.25	48 to 54	57 to 63
	M12X1.25	88 to 98	103 to 113
	M14X1.5	131 to 145	153 to 169
	M16X1.5	214 to 236	248 to 274
	M20X1.5	438 to 484	508 to 562

NOTE: The torque specifications shown in this table correspond to standard torque specifications to be used when no special torque specification is given. These torque specifications are valid for all hardware, with coarse thread, plated or not, coming directly from suppliers.

The hardware can be either dry or lubricated with normal engine oil. They are not suitable in the event of lubrication with special graphite, molybdenum disulphide lubricants or oil. The torque specification values shown in the sections take priority over those shown in the above table.

PLUG AND PLASTIC PLUG REFERENCE

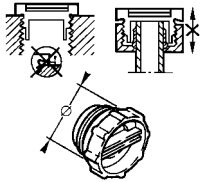
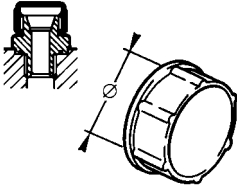
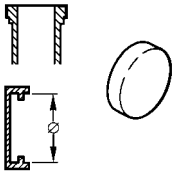
	Dia. x pitch	Part number	Dia. x pitch	Part number
Threaded inserts and screwed plug nut unions  PDG0324	M10x 1.5	F3237416	M20 x 1.5	L3237421
	M12x 1.5	G3237417	M22 x 1.5	M3237422
	M14x 1.5	H3237418	M24 x 1.5	N3237423
	M16x 1.5	J3237419	M27 x 2	Q3237448
	M18x 1.5	K3237420		
Unions = screwable plugs  PDG0325	M12x 1.5	X3237409	M20 x 1.5	C3237413
	M14x 1.5	Z3237410	M22 x 1.5	D3237414
	M16x 1.5	A3237411	M30 x 1.5	E3237415
	M18x 1.5	B3237412		
Pipe or hose S.A.E. collar = external plugs  PDG0326	PN 250 bar		PN 400 bar	
	30.2	J2537460	31.8	P2537465
	38.1	K2537461	41.3	Q2537466
	44.5	L2537462	47.6	R2537467
	50.8	M2537463	54	S2537468
	60.4	N2537464	63.6	T2537469

PN = Nominal pressure

DN = Nominal diameter

TABLE OF LOCTITE PRODUCTS

Product	Colour	Similar products	Clearance in mm	Strength/Solidity (steel / steel)	Operating temperature range (°C)	Setting time (steel / steel)	Fixative	Description
#3	Dark brown	-	-	-	-	24 h	764	Forms a seal (compatible with oil, fuel or grease). Pliable
80	Yellow	-	-	-	-	Quick	764	Seal/Weather seal (for doors, sliding windows)
123	Neutral	-	-	-	-	-	-	Cleaning fluid for components
220	Blue	290	0.076	65/164 Kg/cm ²	-54 to +122	6 min/24h	747	Locking fluid for threads, wick effect
221	Violet	222	0.127	86/50 Kg/cm ²	-54 to +150	2 min/24 h	747	Locking fluid for threads, low strength
222	Violet	-	0.127	51/28 Kg/cm ²	-54 to +150	10 min/24h	747	Locking fluid for threads, low strength (for small screws)
225	Brown	222	0.254	51/28 Kg/cm ²	-54 to +150	7 min/24 h	747	Locking fluid for threads, low strength
242	Blue	-	0.127	92/57 Kg/cm ²	-54 to +150	10 min/24 h	747	Locking fluid for threads, medium strength
262	Red	271	0.127	184/218 Kg/cm ²	-54 to +150	5 min/24 h	747	Locking fluid for threads, high strength
270	Green	271	0.177	184/368 Kg/cm ²	-54 to +150	3 min/24 h	747	Locking fluid for threads, high strength
271	Red	262	0.177	184/368 Kg/cm ²	-54 to +150	10 min/24 h	747	Locking fluid for threads, high strength
272	Red	620	0.254	207/311 Kg/cm ²	-54 to +234	30 min/24 h	747	Locking fluid for threads, high strength, for high temperatures
275	Green	277	0.254	241/345 Kg/cm ²	-54 to +150	3 min/24 h	747	Locking fluid for threads, high strength
277	Red	-	0.254	241/345 Kg/cm ²	- 54 to +150	60 min/24 h	747	Locking fluid for threads, high strength
290	Green	-	0.076	97/403 Kg/cm ²	-54 to +150	6 min/24 h	747	Locking fluid for threads, wick effect
*404	Neutral	495	0.156	224 Kg/cm ²	-54 to +82	30 sec/24 h	-	Instant adhesive
*406	Neutral	-	0.101	224 Kg/cm ²	-54 to +82	15 sec/24 h	-	Adhesive not surface sensitive
*409	Neutral	454	0.203	175 Kg/cm ²	-54 to +82	50 sec/24 h	-	Instant adhesive, gel type
*414	Neutral	-	0.156	175 Kg/cm ²	-54 to +82	30 sec/24 h	-	Instant adhesive
*415	Neutral	454	0.254	175 Kg/cm ²	-54 to +82	50 sec/24 h	-	Instant adhesive, for filling gaps (metals)

* Products with part numbers 404 to 496 (except part number 445) are all instant adhesives (Superglue) but they vary in their viscosity.

Product	Colour	Similar products	Clearance in mm	Strength/Solidity (steel / steel)	Operating temperature range (°C)	Setting time (steel / steel)	Fixative	Description
*416	Neutral	454	0.254	175 Kg/cm ²	-54 to +82	50 sec/24 h	-	Instant adhesive, for filling gaps (plastic materials)
*420	Neutral	-	0.05	175 Kg/cm ²	-54 to +82	15 sec/24 h	-	Instant adhesive, with wick effect
*422	Neutral	454	0.05	196 Kg/cm ²	-54 to +82	60 sec/24 h	-	Instant adhesive, to fill gaps
*430	Neutral	-	0.127	175 Kg/cm ²	-54 to +82	20 sec/24 h	-	Adhesive for glueing metals together
*445	White/black	-	6.35	140 Kg/cm ²	-54 to +82	5 min/24 h	-	Epoxy resin in 2 tubes for quick adhesion
*454	Neutral	-	0.254	224 Kg/cm ²	-54 to +82	15 sec/24 h	-	Instant adhesive, gel type, for inert surfaces
*495	Neutral	-	0.101	175 Kg/cm ²	-54 to +82	20 sec/24 h	-	Instant adhesive for normal uses
*496	Neutral	-	0.127	175 Kg/cm ²	-54 to +82	20 sec/24 h	-	Adhesive for bonding metals together
504	Bright orange	515	0.076	52 Kg/cm ²	-54 to +150	90 min/24 h	None	Removing fluid for rigid sealants
510	Red	-	0.05	70 Kg/cm ²	-54 to +206	30 min/24 h	764	Removing fluid for high temperature sealants
515	Violet	-	0.254	52 Kg/cm ²	-54 to +150	1 h/24 h	764	Removing fluid for No. 515 sealants
518	Red	515	0.076	35 Kg/cm ²	-54 to +150	1 h/24 h	764	Removing fluid for No. 578 sealants for aluminium
542	Brown	569	-	152/106 Kg/cm ²	-54 to +150	2 h/24 h	747	Sealant for hydraulic components
545	Violet	-	-	28/23 Kg/cm ²	-54 to +150	4 h/24 h	747	Sealant for hydraulic/pneumatic components, low strength
549	Orange	504	0.05	175 Kg/cm ²	-54 to +150	2 h/24 h	747	Instant sealant, for plastic joints
554	Red	277	0.381	276/240 Kg/cm ²	- 54 to +150	2 to 4 h/24 h	764	Sealant for coolant solution
567	White	592	-	35 Kg/cm ²	- 54 to +206	4h/24 h	764	Sealant for stainless steel pipes
568	Orange	277	0.381	175 Kg/cm ²	-54 to +150	12 h/24 h	764	Sealant for plastic components
569	Brown	545	0.254	28/46 Kg/cm ²	-54 to +150	1 h/24 h	764	Sealant for hydraulic components
570	Brown	592	-	28/46 Kg/cm ²	-54 to +150	6 h/72h	764	Sealant for steam
571	Brown	592	0.381	46/23 Kg/cm ²	-54 to +150	2 to 4h/24h	764	Sealant for pipes

Product	Colour	Similar products	Clearance in mm	Strength/Solidity (steel / steel)	Operating temperature range (°C)	Setting time (steel / steel)	Fixative	Description
572	White	578 575	-	92/31 Kg/cm ²	-54 to +150	24 h/72 h	None	Sealant
592	White	-	0.05	35 Kg/cm ²	-54 to +206	4h/72 h	736	Sealant for pipes, with Teflon
593	Black	-	6.35	28 Kg/cm ²	-54 to +206	30 min/24 h	-	RTV Silicone
601	Green	609	0.127	210 Kg/cm ²	-54 to +150	10 min/24 h	747	NIP No. 609

<https://caseihservicemanual.com>

<https://caseihservicemanual.com>

Section

1002

GENERAL SPECIFICATIONS

<https://caseihservicemanual.com>

1002

TABLE OF CONTENTS

FLUIDS AND LUBRICANTS	3
Hydraulic fluid.....	3
Transmission component oil	3
Grease	3
Engine oil	4
Oil viscosities / Oil operating ranges	4
Fuel	5
Anti-freeze/anti-corrosion	5
ENVIRONMENT	5
PLASTIC AND RESIN PARTS	6
FLUID AND LUBRICANT CAPACITIES	6
GENERAL MACHINE SPECIFICATIONS.....	7
Engine	7
Hydraulic system	7
Upperstructure swing	7
Undercarriage	7
Safety devices.....	8
Indicators / gauges.....	8
Warning and indicator lamps.....	8
Noise levels	8
Vibration level in operator's compartment	8
Travel	8
WEIGHTS.....	9
DIPPER	9
BACKHOE BUCKET	9
DITCH-CLEANING BUCKET	9
MACHINE OVERALL DIMENSIONS.....	9
WORKING RANGE	10
LIFTING CAPACITY	10



WARNING: *This symbol shows important safety messages. Whenever you see this symbol, carefully read the message which follows, since there is a risk of serious injury.*

FLUIDS AND LUBRICANTS

Fluids and lubricants must correspond to the correct specifications for each type of use.



WARNING: *It is essential to observe the conditions of use of the various fluids and lubricants.*

Hydraulic fluid

Hydraulic fluid is specially made for high pressure use and for the hydraulic system. The type of fluid to be used depends on the ambient temperature.

Temperate climates

-5°C to +40°C
Fluid type ISO VG 46

Hot climates

+5°C to + 55°C
Fluid type ISO VG 68

Cold climates

-20°C to +30°C
Fluid type ISO VG 32

Transmission component oil

Extreme pressure oil used for enclosed transmission components.

Extreme pressure oil TYPE API GL5 GRADE 80W90 or ISO VG 150.

Grease

The type of grease to be used depends on the ambient temperature.

Temperate and hot climates

-20°C to +60°C
Extreme pressure grease EP NLGI grade 2 with molybdenum disulphide.

Cold climates

-40°C to +20°C
Extreme pressure grease EP NLGI grade 0.

<https://caseihservicemanual.com>

Engine oil

The engine oil to be used depends on the ambient temperature.

Use only oil corresponding to the API/CD category.

NOTE: *Never add any performance additive or other additive product to the engine sump. Oil change intervals are shown in this manual in accordance with tests carried out using the lubricants.*

Temperate climates

-5°C to +40°C
Oil type SAE 30

Hot climates

40°C and +
Oil type SAE 40

Cold climates

-30°C to +10°C
Oil type SAE 10W30

Oil viscosities / Oil operating ranges

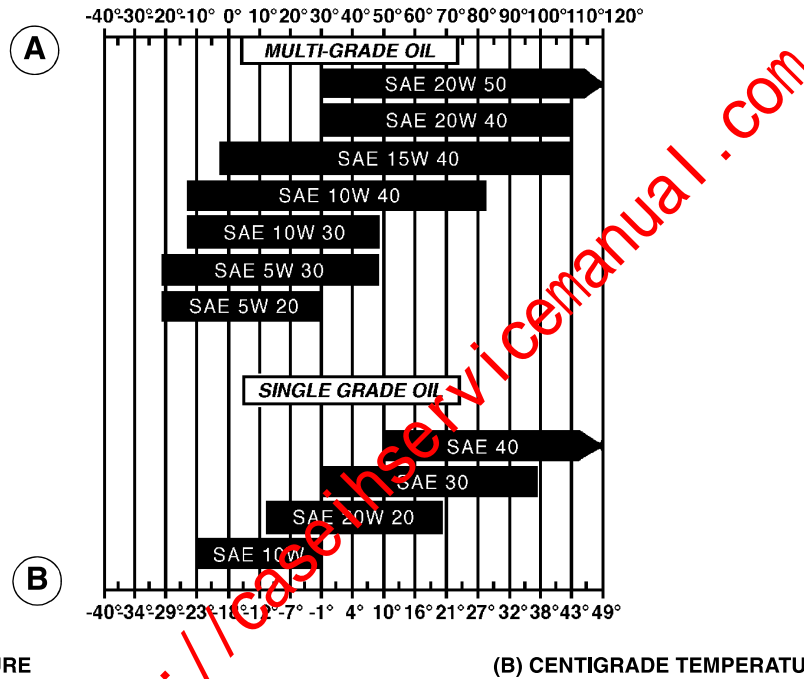

(A) FAHRENHEIT TEMPERATURE

(B) CENTIGRADE TEMPERATURE

1036LO

Fuel

The fuel to be used must conform to standard D975 of the American Society for Testing and Materials (ASTM).

Use fuel type 2. The use of other fuels may cause a loss of engine power and excessive oil consumption.

In cold weather, it is temporarily permitted to mix fuels 1 and 2. Consult your fuel supplier.

If the temperature falls below the fuel cloud point (point at which wax appears), wax crystals in the fuel will cause a loss of engine power or make it impossible to start the engine.

IMPORTANT: *In cold weather, fill the fuel tank at the end of each day's work to prevent the formation of condensation.*

Fuel storage

Prolonged fuel storage encourages the accumulation of foreign bodies or condensation water in the storage tank. Many engine failures are caused by the presence of water in the fuel.

The storage tank must be placed outdoors and the fuel should be kept at the lowest possible temperature. Drain off condensation water at regular intervals.

Anti-freeze/anti-corrosion

Use anti-freeze all year round to protect the cooling system from corrosion and from any risk of freezing.

For environments with a temperature over -36°C , use a mixture of 50% anti-freeze with an ethylene-glycol base.

For environments with a temperature under -36°C , a mixture of 40% water and 60% anti-freeze is recommended.

ENVIRONMENT

Before carrying out any maintenance operation on this machine, and before disposing of used fluids or lubricants, always think of the environment. Never throw oil or fluids on the ground and never place them in leaky receptacles.

Consult your local recycling centre or your Dealer to obtain information on the correct manner of disposing of these substances.

PLASTIC AND RESIN PARTS

When cleaning plastic windows, the console, the instrument panel, the indicators and gauges, etc., do not use petrol, paraffin, paint solvents, etc. Use only water, soap and a soft cloth.

The use of petrol, paraffin, paint solvents, etc. will cause discoloration, cracking or deformation of these parts.

FLUID AND LUBRICANT CAPACITIES

ENGINE

Capacity..... 7.6 litres

COOLING SYSTEM

System capacity 9.8 litres

FUEL SYSTEM

Tank capacity..... 55 litres

HYDRAULIC SYSTEM

Total capacity of system 100 litres

Reservoir capacity 65 litres

SWING REDUCTION GEAR

Capacity (included in hydraulic system)

TRAVEL REDUCTION GEARS

Capacity (per reduction gear) 1.7 litre

<https://caseihservicemanual.com>

GENERAL MACHINE SPECIFICATIONS

Engine

Make and type	MITSUBISHI K4N-EID
Total SAE horsepower	30.6 kW (41 hp)
Diesel, 4 stroke, 4 cylinders.	
Cubic capacity	2290 cm ³
Cooling	water
Battery start	12 volts

Working conditions

Speed without load	2200 rpm
Speed with load	2000 rpm
Horsepower: SAE	30.6 kW (41 hp)
DIN 6271 - CEE 80/1269 - ISO 9249.....	29.1 kW (39 hp)
Capacities: Engine oil sump	7.6 L
Fuel tank	55 L

Hydraulic system

One variable displacement two-body pump supplying the travel and attachment functions.

Flow	2 x 55 L/min
------------	--------------

One fixed displacement pump supplying the upperstructure swing and the dozer blade.

One fixed displacement pump for the servo functions.

Maximum flow.....	100 L/min
-------------------	-----------

Open centre control valves for the attachment, parallel travel, dozer blade and swing.

Flows are per function, regardless of the pressures.

Oil cooler cooled by the engine fan.

High pressure multispiral hoses

minimum safety factor	2 to 4 times working pressure
-----------------------------	-------------------------------

Self-lubricated hydraulic swivel.

Working pressure	206 bar
------------------------	---------

Break-out force (SAE J 1179)	3160 daN
------------------------------------	----------

Crowd force (SAE J 1179)	2355 daN
--------------------------------	----------

Hydraulic reservoir capacity	65 L
------------------------------------	------

Total hydraulic system capacity	100 L
---------------------------------------	-------

Upperstructure swing

Axial piston hydraulic motor with braking valve.

Ball bearing turntable.

Swing speed	9.1/4.6 rpm
-------------------	-------------

Attachment offset angle.....	right-hand 90°, left-hand 80°
------------------------------	-------------------------------

Undercarriage

Welded, monoblock chassis.

Lubricated rollers and idler wheels.

Grease type track tension, shock absorption by spring.

Rubber tracks	400 mm
---------------------	--------

Dozer blade	1840 mm x 350 mm
-------------------	------------------

Ground pressure.....	0.260 bar
----------------------	-----------

Ground clearance	330 mm
------------------------	--------

Safety devices

Controls are cancelled when left-hand control arm is raised.

Safety glass.

Audible warning device.

Indicators / gauges

Engine coolant solution temperature gauge, hourmeter.

Warning and indicator lamps

Pre-heating, engine oil pressure, battery charge, minimum fuel level, air filter restriction and coolant solution temperature.

Noise levels

Guaranteed by the manufacturer.

As per European Directive No. 86/662/CEE.

Inside operator's compartment (LpA)81 decibels

Outside operator's compartment (LwA)97 decibels

Vibration level in operator's compartment

Lower members below 2.5 m/s²

Abdomen below 0.5 m/s²

Travel

Sprockets driven by hydraulic motors.

Independent drive to each track.

Travel speeds 2.9 - 4.7 kph

Gradeability 60%

<https://caseih.servicemanual.com>

WEIGHTS

Machine with cab and standard equipment.....	4650 kg
Cab	120 kg
Counterweight	426 kg

DIPPER

Length.....	1.45 m
	1.75 m

BACKHOE BUCKET

SAE capacity	60 L	104 L	152 L	201 L	218 L
Width	0.30 m	0.45 m	0.60 m	0.75 m	0.80 m
Width with side cutters	0.32 m	0.48 m	0.63 m	0.78 m	0.83 m

DITCH-CLEANING BUCKET

SAE capacity	239 L	275 L
Width	1.40 m	1.60 m

MACHINE OVERALL DIMENSIONS

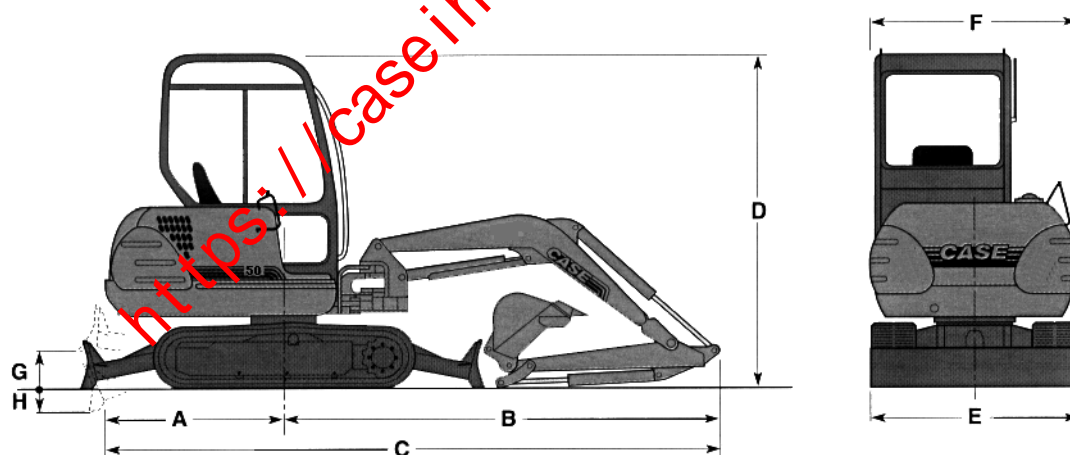

A.....	1.43 m
B.....	4.08 m
C.....	6.51 m
D.....	2.66 m
E.....	1.84 m
F.....	1.67 m
G.....	0.37 m
H.....	0.36 m

CS98A194

WORKING RANGE

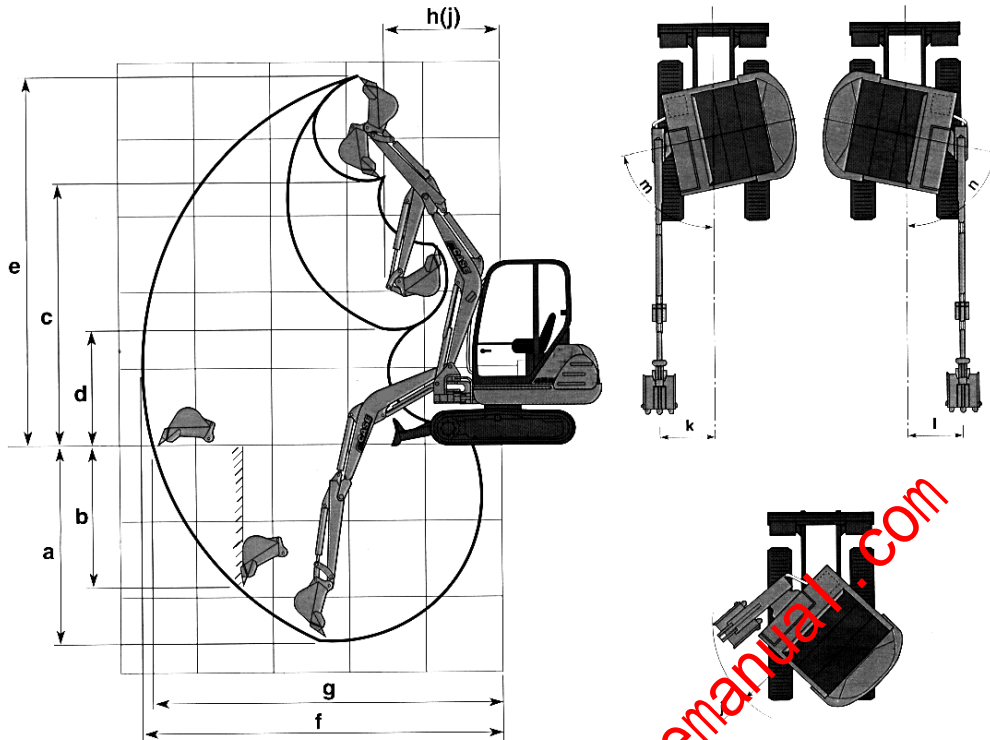

	CS98B260	
Dipper.....	1.45 m	1.75 m
a.....	3.50 m	3.80 m
b.....	2.80 m	3.14 m
c.....	4.00 m	4.20 m
d.....	1.60 m	1.30 m
e.....	5.60 m	5.82 m
f.....	5.92 m	6.22 m
g.....	5.76 m	6.07 m
h (in line).....	1.92 m	
j (offset).....	2.36 m	2.38 m
k.....	0.88 m	0.88 m
l.....	0.70 m	0.70 m
m (left-hand).....	80°	80°
n (right-hand).....	90°	90°

NOTE: * A hydraulic hammer cannot be currently fitted.

LIFTING CAPACITY

Reach at ground level	In line		To the side
	With dozer blade	Without dozer blade	
4.00 m	1300 kg*	800 kg	600 kg
5.00 m	900 kg*	500 kg	400 kg

* Hydraulic limit

NOTE: The lifting capacities correspond to 87% of the hydraulic limits of the machine and to 75% of the tipping load. The machine is equipped with its bucket in the closed position.

Section

2000

ENGINE REMOVAL AND INSTALLATION

<https://caseihservicemanual.com>

TABLE OF CONTENTS

SPECIFICATIONS.....	2
TORQUE SPECIFICATIONS	2
TOOLS REQUIRED	2
ENGINE REMOVAL AND INSTALLATION.....	3



WARNING: This symbol is used in this manual to show important safety messages. Whenever you see this symbol, carefully read the message which follows, since there is a risk of serious injury.

SPECIFICATIONS

Hydraulic reservoir capacity	65 L
Fuel tank capacity.....	55 L
Engine oil capacity.....	7.5 L
Coolant solution capacity.....	9.8 L

TORQUE SPECIFICATIONS

Main pump retaining screws.....	148 to 180 Nm
Engine retaining screws	70 to 76 Nm
Exhaust clamp screws.....	18 to 22 Nm

TOOLS REQUIRED

- Torque wrench (20 to 200 Nm)
- Loctite 262, 271
- Two slings (300 kg)

<https://caseihservicemanual.com>

ENGINE REMOVAL AND INSTALLATION



WARNING: The engine and hydraulic pump components attain high temperatures when the machine is operating. To avoid being burnt by hot metal or scalded by high temperature water or oil, allow the machine to cool down before starting any operation.

STEP 1

Park the machine on flat, horizontal ground, lower the attachment to the ground and stop the engine.

STEP 2

Disconnect the cables from the battery, starting with the negative terminal (-).

NOTE: When installing, connect the positive cable (+) first.

STEP 3

Remove the counterweight and the rear hood (See Section 9002). Remove the engine and main pump lower panels.

STEP 4

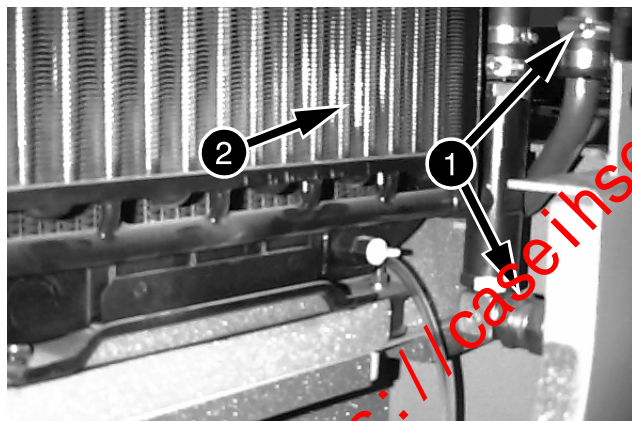

CD98C006

Release pressure in the hydraulic system, disconnect the hoses (1) from the oil cooler (2) and drain the hydraulic reservoir.

STEP 5

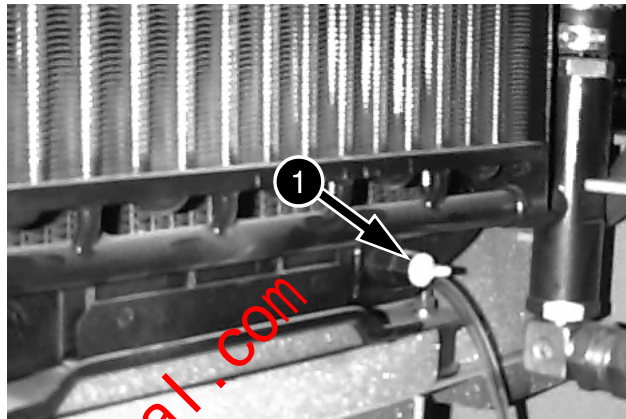

CD98C006

Drain the water radiator by means of the valve (1).

STEP 6

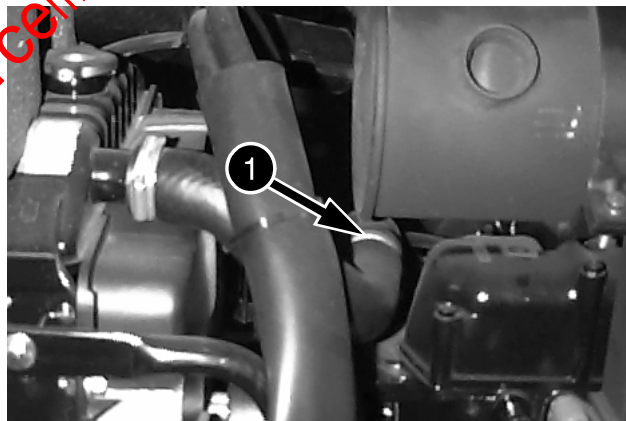

CD98C021

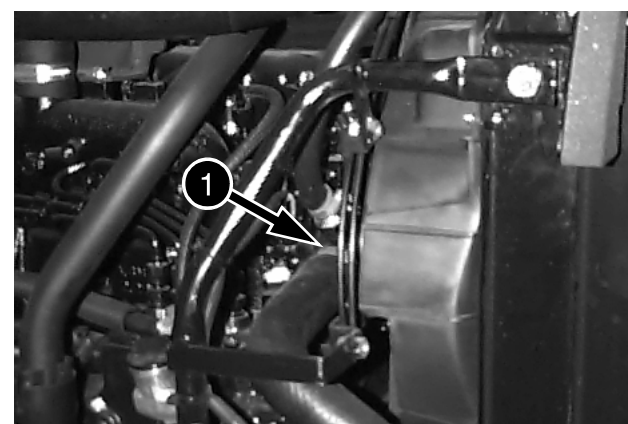

CD98C003

Remove the engine cooling hoses (1), disconnecting them from the engine end.

STEP 7

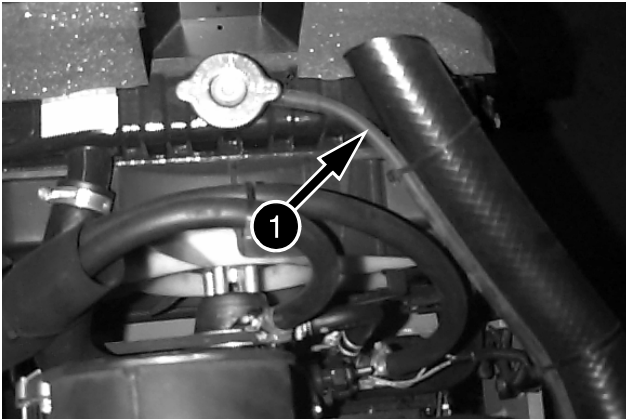

CD98C005

Remove the hose (1) going to the expansion reservoir.

STEP 8

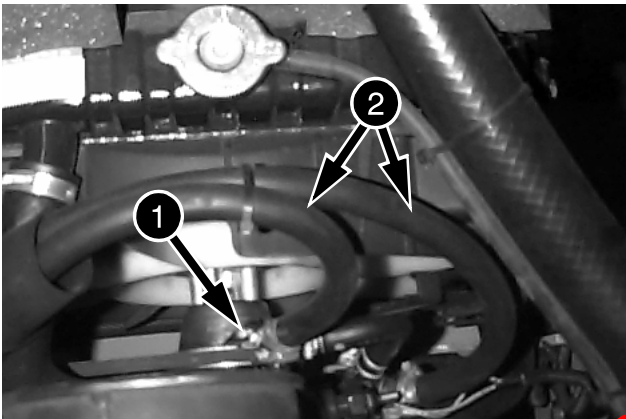

CD98C006

Close the heater valve (1) and drain the heater system by removing the two hoses (2).

NOTE: When installing, do not forget to open the heater valve.

STEP 9

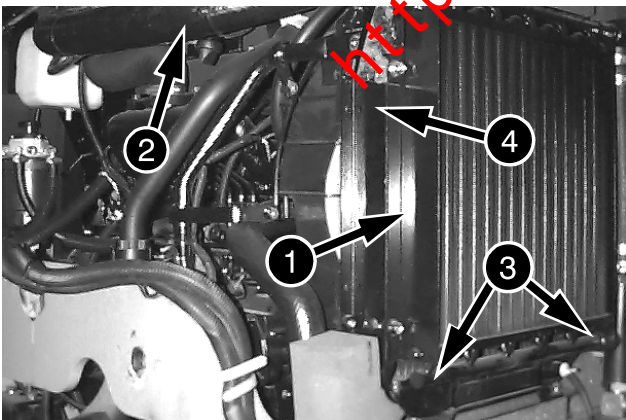

CD98C024

Remove the cooling system (1) (radiator, fan shroud, oil cooler), first removing the air filter supply hose (2) and unscrewing the retaining screws (3) and (4).

STEP 10

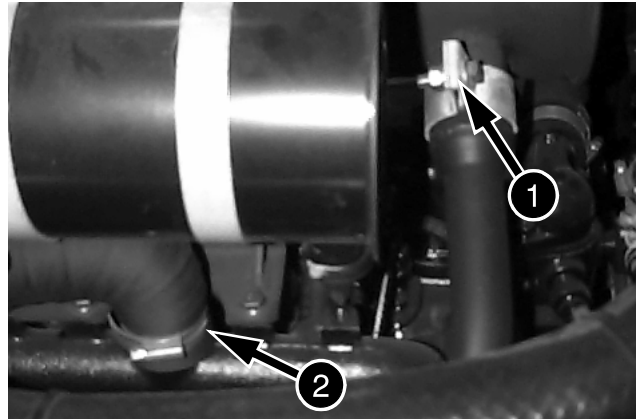

CD98C026

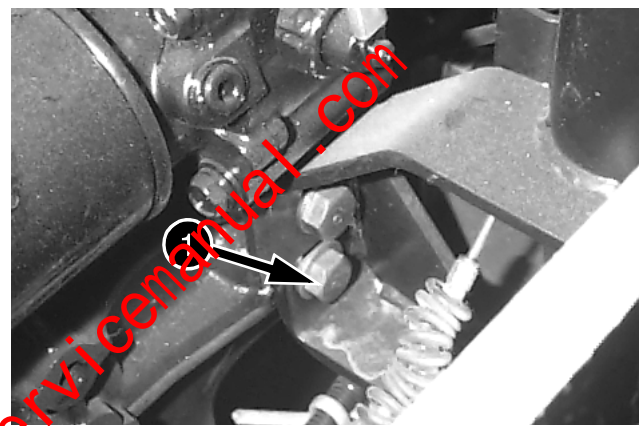

CD98C025

Remove the exhaust clamps (1). Remove the air filter hose (2).

STEP 11

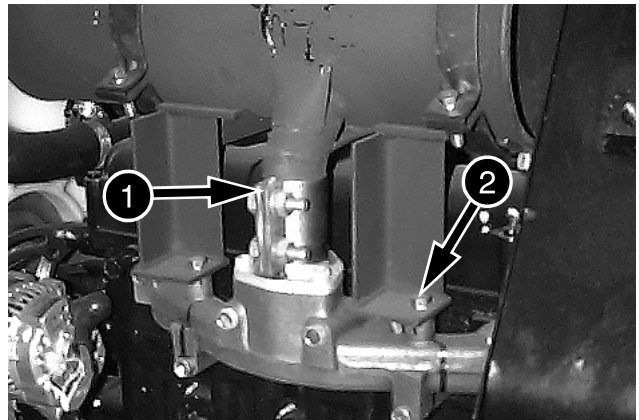

CD98C023

Remove the clamp (1) from the silencer. Remove the exhaust and air filter bracket by unscrewing the five retaining screws (2).